

Wear Strips

UHMW/PE

C Profiles

- Low friction, wear resistant, non-marring protective cover
- Reduces noise
- Ultra smooth surface finish- no Ram lines
- Can be used with Aluminum extrusions on page 10
- Impervious to moisture

Standard UHMW/PE wear strips/C shapes are white and come in 10 ft. and 20 ft. lengths
Easily available with Anti-Static, Lubricated, and Anti-Microbial additives.

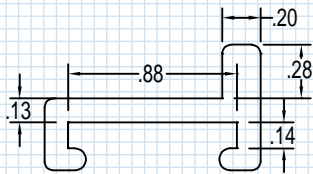

SPX 1022849
CAT CC-012-087-F
AR-20 Assembly

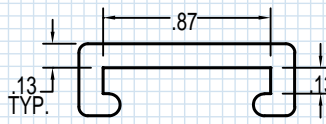

SPX 1002628
CAT CC-012-087
AR-20 Assembly

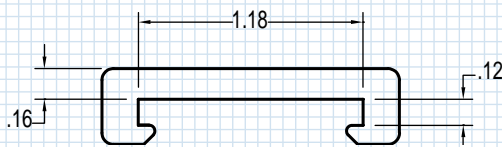

SPX 1012747
CAT CD-012-118

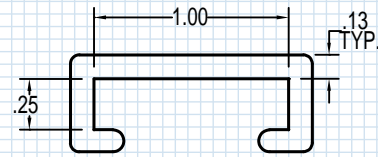

SPX 1002641
CAT CC-025-100
Fits 1/4" x 1" Bar

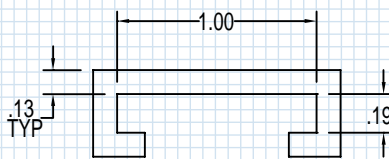

SPX 1760731
CAT CC-019-100
Fits 3/16" x 1" Bar

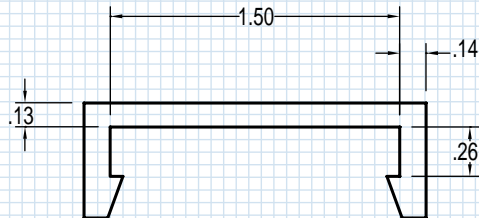

SPX 1952103
CAT PC-025-150
Fits 1/4" x 1 1/2" Bar

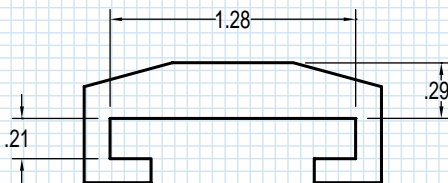

SPX 1780875
CAT PF-875
Fits 1 1/4" x 3/16" Bar

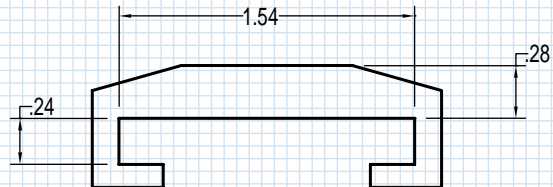

SPX 1831156
CAT PF-1156
Fits 1 1/2" x 3/16" Bar

Wear Strips

UHMW/PE

C Profiles...continued

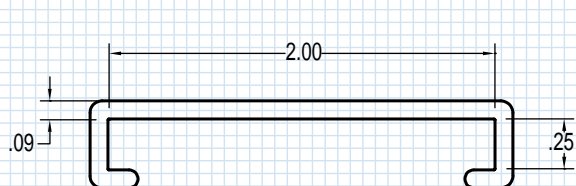

SPX 1002639
CAT CB-025-200
Fits 1/4" x 2" Bar or AR-60 Aluminum Rail

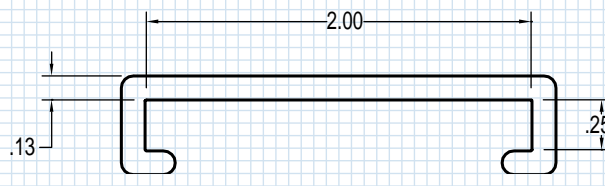

SPX 1012738
CAT CC-025-200
Fits 1/4" x 2" Bar or AR-60 Aluminum Rail

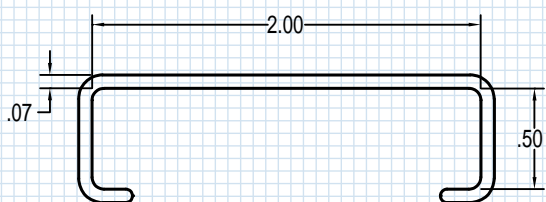

SPX 1012764
CAT CA-050-200
Fits 1/2" x 2" Bar

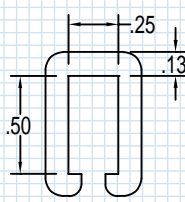

SPX 1022870
CAT CC-050-025
Fits 1/2" x 1/4" Bar

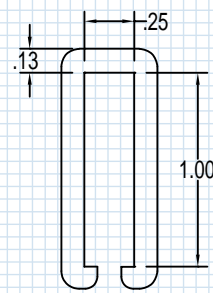

SPX 1022871
CAT CC-100-025
Fits 1" x 1/4" Bar

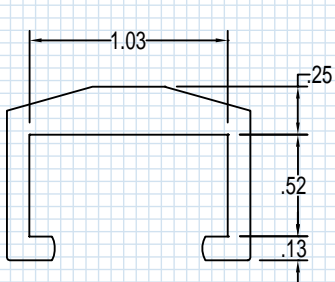

SPX 1012722
CAT PF-2722
Fits 1/2" x 1" Bar

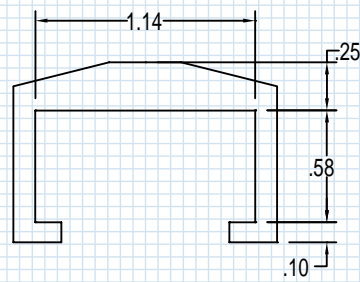

SPX 1012724
CAT PF-1845
Fits 9/16" x 1 1/8" Bar

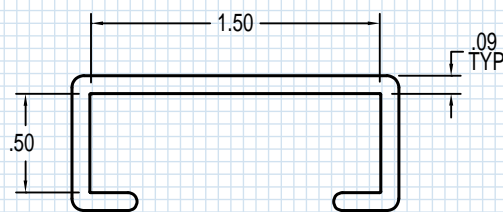

SPX 1002638
CAT CB-050-150
Fits 1/2" x 1 1/2" Bar

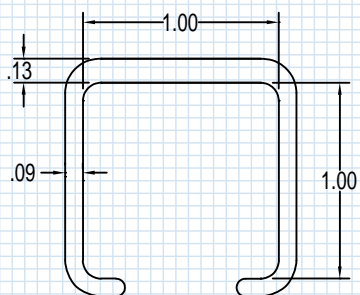

SPX 1012755
CAT CB-100-100
Fits 1" x 1" Bar

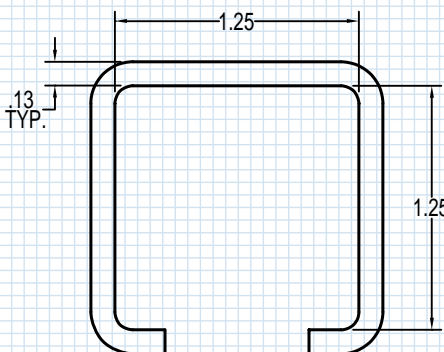

SPX 1032876
CAT CC-125-125
Fits 1 1/4" x 1 1/4" Bar

Wear Strips

UHMW/PE

C Profiles...continued

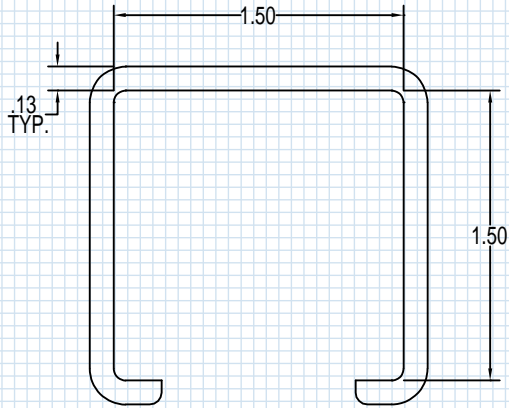

SPX 1022866
CAT CC-150-150
Fits 1/2" x 1/2" Bar

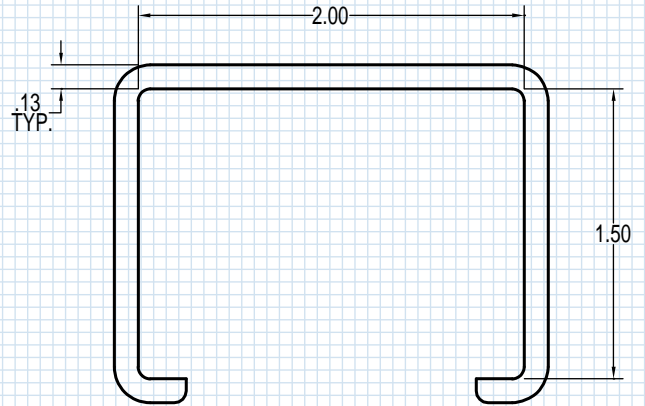

SPX 1012709
CAT CC-150-200
Fits 1/2" x 2" Bar

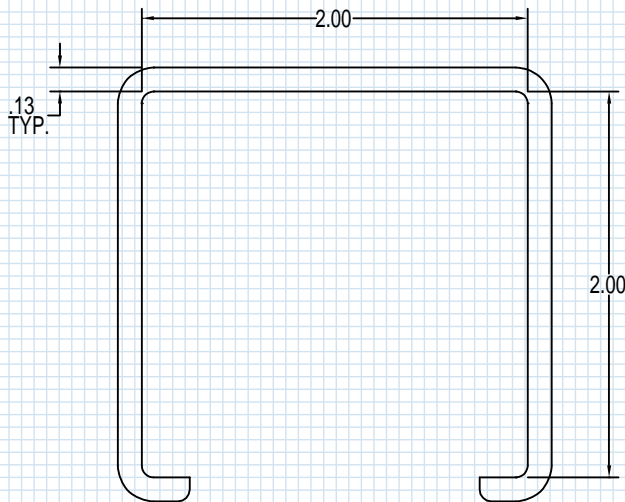

SPX 1063588
CAT CC-200-200
Fits 2" x 2" Bar

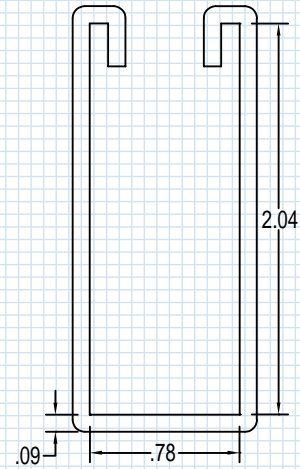

SPX 1962203
CAT LD-10
Cover for Lane Divider AR-70